

XRD™ 680S PLUS

600 WATT STEREO
POWERED MIXER

OPERATING GUIDE





Intended to alert the user to the presence of uninsulated "dangerous voltage" within the product's enclosure that may be of sufficient magnitude to constitute a risk of electric shock to persons.



Intended to alert the user of the presence of important operating and maintenance (servicing) instructions in the literature accompanying the product.

CAUTION: Risk of electrical shock – DO NOT OPEN!

CAUTION: To reduce the risk of electric shock, do not remove cover. No user serviceable parts inside. Refer servicing to qualified service personnel.

WARNING: To prevent electrical shock or fire hazard, do not expose this appliance to rain or moisture. Before using this appliance, read the operating guide for further warnings.



Este símbolo tiene el propósito de alertar al usuario de la presencia de "(voltaje) peligroso" que no tiene aislamiento dentro de la caja del producto que puede tener una magnitud suficiente como para constituir riesgo de corrientazo.



Este símbolo tiene el propósito de alertar al usuario de la presencia de instrucciones importantes sobre la operación y mantenimiento en la literatura que viene con el producto.

PRECAUCION: Riesgo de corrientazo – No abra.

PRECAUCION: Para disminuir el riesgo de corrientazo, no abra la cubierta. No hay piezas adentro que el usuario pueda reparar. Deje todo mantenimiento a los técnicos calificados.

ADVERTENCIA: Para evitar corrientazos o peligro de incendio, no deje expuesto a la lluvia o humedad este aparato. Antes de usar este aparato, lea más advertencias en la guía de operación.



Ce symbole est utilisé pour indiquer à l'utilisateur la présence à l'intérieur de ce produit de tension non-isolée dangereuse pouvant être d'intensité suffisante pour constituer un risque de choc électrique.



Ce symbole est utilisé pour indiquer à l'utilisateur qu'il ou qu'elle trouvera d'importantes instructions sur l'utilisation et l'entretien (service) de l'appareil dans la littérature accompagnant le produit.

ATTENTION: Risques de choc électrique – NE PAS OUVRIR!

ATTENTION: Afin de réduire le risque de choc électrique, ne pas enlever le couvercle. Il ne se trouve à l'intérieur aucune pièce pouvant être réparée par l'utilisateur. Confier l'entretien à un personnel qualifié.

AVERTISSEMENT: Afin de prévenir les risques de décharge électrique ou de feu, n'exposez pas cet appareil à la pluie ou à l'humidité. Avant d'utiliser cet appareil, lisez les avertissements supplémentaires situés dans le guide.



Dieses Symbol soll den Anwender vor unisolierten gefährlichen Spannungen innerhalb des Gehäuses warnen, die von Ausreichender Stärke sind, um einen elektrischen Schlag verursachen zu können.



Dieses Symbol soll den Benutzer auf wichtige Instruktionen in der Bedienungsanleitung aufmerksam machen, die Handhabung und Wartung des Produkts betreffen.

VORSICHT: Risiko – Elektrischer Schlag! Nicht öffnen!

VORSICHT: Um das Risiko eines elektrischen Schlages zu vermeiden, nicht die Abdeckung entfernen. Es befinden sich keine Teile darin, die vom Anwender repariert werden könnten. Reparaturen nur von qualifiziertem Fachpersonal durchführen lassen.

ACHTUNG: Um einen elektrischen Schlag oder Feuergefahr zu vermeiden, sollte dieses Gerät nicht dem Regen oder Feuchtigkeit ausgesetzt werden. Vor Inbetriebnahme unbedingt die Bedienungsanleitung lesen.

ENGLISH

Thank you for purchasing the Peavey XRD™ 680S Plus mixer which features built-in stereo digital effects and 300 watt stereo amplifiers, giving a total output power of 600 watts. This is a powerful, easy-to-use, portable, eight-channel mixing console. Each channel features front-panel output and monitor level controls, as well as high, mid, and low equalization, and effects emphasis controls. Every input channel has a studio-quality, low impedance (XLR-type input) microphone input, as well as a 1/4" line input. Switchable +48 V phantom power is provided.

Your XRD™ 680S Plus features a rugged, heavy-gauge, cold-rolled steel and aluminum chassis, finished in oven-cured epoxy for toughness, and screen-printed utilizing the latest photographic film and U.V.-cured ink technology for razor-sharp, hard-wearing control I.D. and calibration graphics. Every on-board component has been carefully chosen to deliver the highest possible performance. All printed circuit boards are constructed from rugged, U.S. military-spec material using the latest automated assembly technology, wave solder, and computer-controlled "all-faults-analyzed-and-corrected" Q.A. procedures.

Precision, professional reliability, and minimal operating noise characteristics are only among the initial criteria used during the process of selecting the components that ensure that your XRD™ 680S Plus becomes an indispensable addition to your live performance equipment.

FRONT PANEL FEATURES

BALANCED LOW IMPEDANCE INPUT (1)

For use with low impedance microphones or low-level sources equipped with an XLR connector.

LINE INPUT JACK (2)

For use with line-level signal or compatible high-Z microphones equipped with a 1/4" phone plug.

NOTE: It is possible to use both the mic and line inputs on a single channel simultaneously. It is, however, unlikely that the gain matching of the mic and line will allow this hookup to be useful. This practice is not recommended.

LEVEL (3)

Controls the channel output level. Maximum output level is obtained by rotating this control fully clockwise. Minimum output level is obtained by rotating this control fully counterclockwise.

PAN (4)

Provides an individual channel pan L-to-R facility. Center position delivers equal L & R stereo image balance.

MONITOR (5)

Controls the channel monitor mix level. This is independent of all other channel controls. Maximum channel monitor mix level is obtained by rotating this control fully clockwise. Minimum channel monitor mix level is obtained by rotating this control fully counterclockwise.

LOW EQ (6)

Controls the channel low EQ level. An active tone control (shelving type, ± 15 dB) that varies the low frequency range. Maximum low EQ *boost* is obtained by rotating this control fully clockwise. Maximum low EQ *cut* is obtained by rotating this control fully counterclockwise.

Front Panel:



MID EQ (7)

Controls the channel mid-EQ level. An active tone control (peak/notch, ± 15 dB) that adjusts the mid-frequency range. Maximum mid-EQ *boost* is obtained by rotating this control fully clockwise. Maximum mid-EQ *cut* is obtained by rotating this control fully counterclockwise.

HIGH EQ (8)

Controls the channel high EQ level. An active tone control (shelving type, ± 15 dB) that varies the high frequency range. Maximum high EQ *boost* is obtained by rotating this control fully clockwise. Maximum high EQ *cut* is obtained by rotating this control fully counterclockwise.

EFFECTS SEND (9)

Controls the channel effects drive level. Maximum effects signal is obtained by rotating the control fully clockwise. Minimum signal level is obtained by rotating this control fully counterclockwise.

MASTER

EFFECTS SELECTOR (10)

Rotating the EFFECTS SELECTOR control determines which particular digital effect is drawn from whichever bank has been selected by means of the TIME SELECTOR switch.

TIME SELECTOR (11)

Rotating the TIME SELECTOR control determines which particular digital time is selected for use. As will be seen from the front panel illustration, digital effect times are available from small room reverbs through extra large rooms, gated reverbs, delays, echoes, and multi-effects.

NOTE: Refer to the chart printed on the faceplate and select one of the 128 effects using the TIME and SELECT switches. There are 16 effects settings for each TIME. Use the TIME switch to choose the type of effect and the SELECT switch to choose which variation of this effect to use.

EFFECTS TO MONITOR (12)

Controls the level of the EFFECTS in the monitor system. Maximum monitor effects signal level is obtained by rotating this control fully clockwise. Minimum monitor effects signal level is obtained by rotating this control fully counterclockwise.

EFFECTS RETURN (13)

Controls the level of the EFFECTS in the main system mix. Maximum effects return signal level is obtained by rotating the control fully clockwise. Minimum effects return signal level is obtained by rotating this control fully counterclockwise.

TAPE ~~OUT~~ STEREO LEVEL (14)

Controls the signal level at the TAPE-~~OUT~~ JACKS ^{IN} (17). Operation is independent of the main MASTER level control (20) and the GRAPHIC EQUALIZER (19).

TAPE AUX TO MON (15)

Allows the TAPE/AUX to be assigned to the monitor.

TAPE OUT JACKS (16)

These two jacks provide left and right main outputs to the left and right inputs of a stereo tape deck. Output level is determined by the TAPE OUT STEREO LEVEL control (14).

TAPE IN JACKS (17)

These two jacks provide an input for stereo tape decks, CD players, etc.

TAPE OUT/TAPE IN: CAUTION!

Before placing connected tape decks in the "record" mode, set the TAPE/AUX IN level control to "0" or off. Most tape decks feed the input signal directly to the output when in record mode. This creates a "closed loop" condition from the tape-out to tape-in jack which can affect the operational level or sonic quality of the system.

PILOT LIGHT LED (18)

Illuminates when AC power is being supplied to the amp.

STEREO 9-BAND GRAPHIC EQ (19)

Provides ± 12 dB equalization at each center frequency. EQ boost is obtained by moving a particular EQ band's slide control above the center line. EQ cut is obtained by moving a particular EQ band's slide control below the center line.

OPERATION NOTE: This equalizer is designed to provide room equalization, feedback control, and system tone control. No amount of equalization will correct the response curve of a poor loudspeaker. Always begin with all sliders in the "0" position and avoid excessively cutting/boosting large segments of the audio passband, which would limit the system's dynamic range.

MASTER GAIN (20)

Controls the overall volume level of the main system. The signal from this control is available at the MAIN OUTPUT (31). Under normal conditions this signal is also internally patched through the graphic EQ and power amplifier so that this control sets the volume of the speakers connected to the EXTERNAL SPEAKER JACKS (36). Maximum master signal level is obtained by rotating this control fully clockwise. Minimum master signal level is obtained by rotating this control fully counterclockwise.

MASTER MONITOR (21)

Controls the overall monitor mix level. Maximum monitor signal level is obtained by rotating this control fully clockwise. Minimum monitor signal level is obtained by rotating this control fully counterclockwise.

EFFECTS MASTER (22)

Controls the effects level supplied to the internal reverb and the effects out jack. Maximum effects signal level is obtained by rotating this control fully clockwise. Minimum effects signal level is obtained by rotating this control fully counterclockwise.

MASTER OUTPUT/INPUT

TAPE/AUX IN LEVEL (23)

When external signals are patched into the TAPE-IN JACKS (17) or the AUXILIARY INPUTS (25), TAPE/AUX IN LEVEL provides control over the level of signals sent from these inputs to the main left and right mixes. Maximum TAPE/AUX to main mix signal level is obtained by rotating this control fully clockwise. Minimum TAPE/AUX to main mix signal level is obtained by rotating this control fully counterclockwise.

NOTE: It is possible to use both the AUX and TAPE inputs simultaneously. It is, however, unlikely that the gain matching of the AUX and TAPE will allow this hookup to be useful. This practice is not recommended.

POWER AMP INPUTS (24)

These 1/4" jacks provide access to connect external line-level signals to the left and right power amplifiers.

OPERATION NOTE: These jacks permit the two internal power amplifiers to be switched away from their normal inputs and to accept external line-level signals.

AUXILIARY INPUTS (25)

These 1/4" jacks provide inputs to the left and right main mixing buses and the monitor mixing bus for patching returns from external effects devices, extra mixing channels, etc. If the auxiliary signal is mono, plug a mono 1/4" plug into the L/MONO jack. If the auxiliary signal is stereo, plug the left signal into the L/MONO jack and the right signal into the R jack.

EFFECTS FOOTSWITCH (26)

This 1/4" jack provides access for connection of a footswitch (optional) and is used to activate/defeat digital effects.

GRAPHIC EQ OUT (27)

This 1/4" jack provides access to the output of the internal graphic equalizer. This is a TRS (Tip-Ring-Sleeve) switching jack. A stereo 1/4" plug inserted here will have the left signal on the tip and the right signal on the ring. Do not use a mono plug on this output unless a mono plug is also plugged into the GRAPHIC EQ INPUT (28).

GRAPHIC EQ INPUT (28)

This 1/4" jack provides an input to the internal graphic equalizer/power amp. This is a TRS (tip-ring-sleeve) switching jack, and a signal inserted here interrupts the normal signal path from the main bus into the equalizer.

OPERATION NOTE: This jack permits the equalizer to be switched away from its normal input and accept an external signal to be equalized. If a stereo signal is to be equalized, the left signal should be connected to the tip, and the right signal should be connected to the ring of a stereo 1/4" plug. If a mono 1/4" plug is used, signal will only go to the left graphic. The right graphic will get no signal.

EFFECTS OUTPUT (29)

This 1/4" jack provides a signal from the EFFECTS mix for external effects or signal-processing equipment.

MONITOR OUTPUT (30)

This 1/4" jack provides a signal from the MONITOR mix for an external monitor amplifier/speaker system. The level is determined by the channel monitor and master monitor controls.

MAIN OUTPUT (31)

These 1/4" jacks provide a stereo signal from the main system mix before the graphic equalizer. Used primarily to feed an auxiliary amplifier/speaker system. (See wiring diagram.)

PHANTOM POWER ON/OFF (32)

This switch selects phantom power "on" or "off" for all channels. Phantom power is "on" when the switch is in the down position and "off" when the switch is in the up position.

Back Panel:

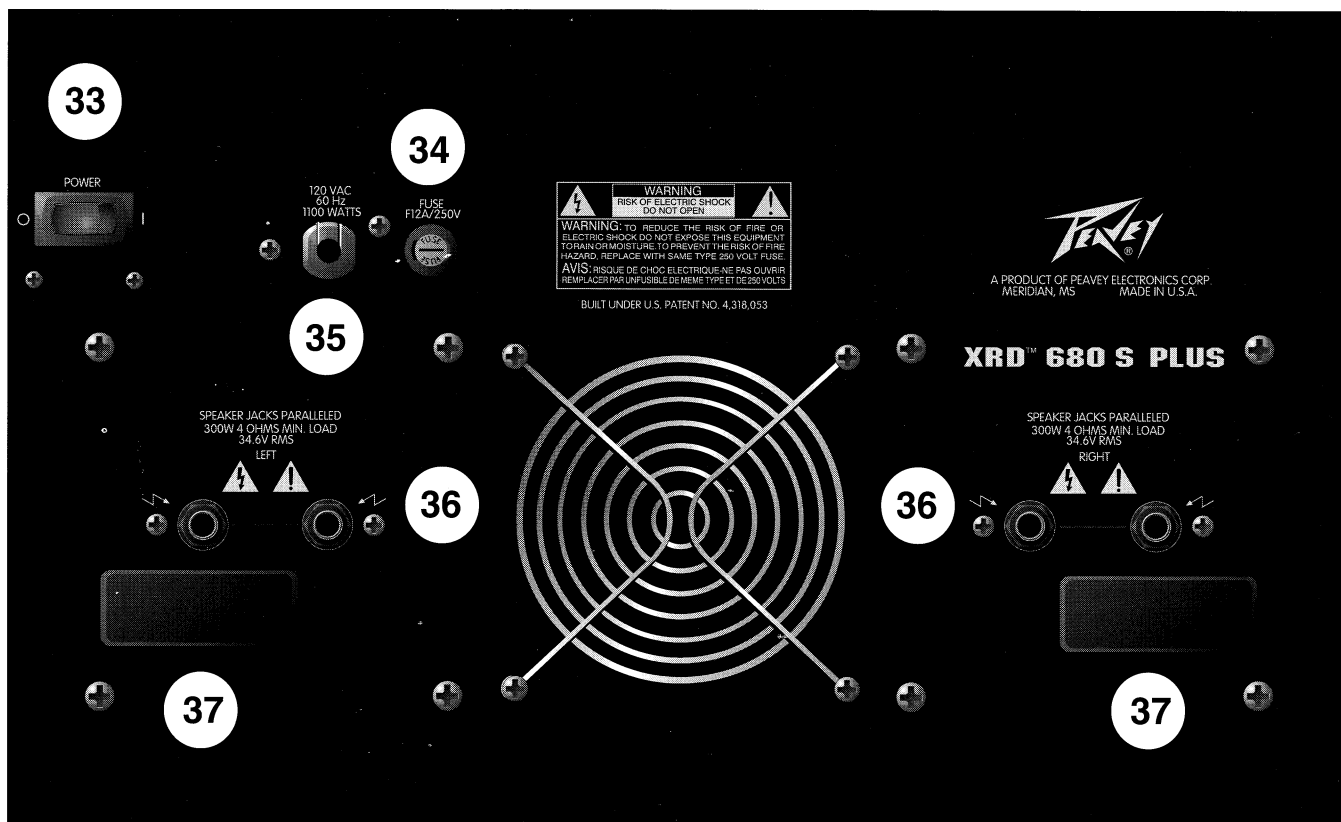

BACK PANEL FEATURES

POWER SWITCH (33)

Used to turn AC mains power on or off.

FUSE (34)



WARNING: THE FUSE SHOULD ONLY BE REPLACED WHEN THE POWER CORD HAS BEEN DISCONNECTED FROM ITS POWER SOURCE.

CAUTION: USING A FUSE LARGER THAN THE RECOMMENDED SIZE COULD RESULT IN PERMANENT DAMAGE TO THE AMPLIFIER.



The fuse is located within the cap of the fuseholder. If the fuse should fail, IT MUST BE REPLACED WITH THE SAME TYPE AND VALUE IN ORDER TO AVOID DAMAGE TO THE EQUIPMENT AND TO PREVENT VOIDING THE WARRANTY. If the unit repeatedly blows fuses, it should be taken to a qualified service center for repair.

LINE CORD (35) (120 V products only)

For your safety, we have incorporated a three-wire line (mains) cable with proper grounding facilities. It is not advisable to remove the ground pin under any circumstances. If it is necessary to use the equipment without proper grounding facilities, suitable grounding adaptors should be used. Less noise and greatly reduced shock hazard exists when the unit is operated with the proper grounded receptacles.

EXTERNAL SPEAKER JACKS (36)



Provided for connection of external speaker cabinet. Minimum total impedance is 4 ohms for each amplifier.

LINE (MAINS) CORD RETAINERS (37)

Allow storage of mains cable for travel.

NOTE: The line cord should be removed from the cord retainers before use.

SPECIFICATIONS

NOTE: All specifications are typical unless otherwise noted.

0 dBV = 1 volt RMS

0 dBu = 0.778 volts RMS

All specifications are referenced to nominal output level (0 dBV) unless otherwise noted.

All measurements are wide band 20 Hz to 20 kHz unless otherwise stated.

All control settings are nominal (50% rotation) unless otherwise noted.

CHANNEL

Equivalent Input Noise:

-114.5 dBV at 40 dB max gain

Frequency Response:

(to speaker outputs)

±1 dB, 10 Hz to 23 kHz

Distortion:

(1 kHz)

Less than 0.015%

Input Impedance:

Low-Z Bal = 1.7 k ohms

Line Input = 13 k ohms

High EQ:

±15 dB at 10 kHz minimum

Center detent flat ±2 dB

Mid EQ:

±15 dB at 600 Hz minimum

Center detent flat ±2 dB

Low EQ:

±15 dB at 50 Hz minimum

Center detent flat ±2 dB

Nominal Channel Gain:

Low-Z = 20 dB

Line = 0 dB

Minimum Channel Gain:

Low-Z = -69 dB

Line = -89 dB

Maximum Channel Gain:

Low-Z = 40 dB

Line = 20 dB

Nominal Input Level:

Low-Z = -20 dBV

Line = 0 dBV

Minimum Input Level:

Low-Z = -40 dBV

Line = -20 dBV

Maximum Input Level:

Low-Z = +6 dB

Line = +26 dB

Phantom Power:

+48 V DC

GRAPHIC EQUALIZER

Filter Bandwidth:

1 octave

Filter Frequencies:

(ISO Stds.)

63 Hz, 125 Hz, 250 Hz, 1 kHz, 2 kHz, 4 kHz, 8 kHz,

16 kHz

Filter Q:

1.57

Maximum Boost & Cut:

±12 dB

Noise:

-102 dBV

Distortion:

(1 kHz)

Less than 0.005%

Frequency Response:

±1 dB, 7 Hz to 40 kHz

Input Level:

Nom = 0 dBV (1.0 V RMS)

Max = +19 dBV (9 V RMS)

Output Level:

Nom = 0 dBV (1.0 V RMS)

Max = +19 dBV (9 V RMS)

Input Impedance:

10 k ohms

Output Impedance:

100 ohms

MASTER

Gain:

Main: 20 dB

Monitor: 15 dB

Tape: 15 dB

Effects: 15 dB

Maximum Output Level:

Main: +18 dBV (8.0 V RMS)

Monitor: +18 dBV (8.0 V RMS)

Tape: +18 dBV (8.0 V RMS)

Effects: +18 dBV (8.0 V RMS)

Nominal Headroom:

Main: 18 dB
 Monitor: 18 dB
 Tape: 18 dB
 Effects: 18 dB

Output Impedance:

Main: 100 ohms
 Monitor: 100 ohms
 Tape: 10 k ohms
 Effects: 100 ohms

Output Noise:

Residual: -101 dBV
(Master level down)
Bus: -94 dBV
(Master nominal, all channel levels full CCW, Effects Returns down)
Nominal: -86 dBV
(all controls nominal, Low-Z input terminated 150 ohms)

Aux Input Impedance:

120 k ohms

Aux Input Level:

Nom: 0 dBV
 Max: +7 dBV
 Min: -15 dBV

Tape Input Level:

Nom: +4 dBV
 Max: +11 dBV
 Min: -10 dBV

DIGITAL EFFECTS PROCESSOR**Reverberation Settings:**

32 reverb positions
 1 bypass setting
 13 warm reverbs
 13 bright reverbs
 2 gated reverbs
 2 reverse reverbs

Frequency Response:

20 Hz to 11 kHz

Quantization:

16-Bit Linear PCM

Signal-To-Noise Ratio:

95 dB Minimum

Headroom:

6 dB at Limit LED Illumination

POWER AMP**Input Sensitivity:**

1.0 volts *(for rated output)*

Output Power:

34.6 V RMS/CH at 120 V AC line, 1 kHz input signal

Single Amplifier:

300 watts at 4 ohms
 150 watts at 8 ohms

Both Amplifiers:

300 watts at 4 ohms
 150 watts at 8 ohms
(2 ohm operation not recommended)

**Total Harmonic Distortion:**

Less than 0.1% 100 mV to Rated Power 20 Hz to 10 kHz, 4 ohms *(typically below 0.05%)*

Compression:

DDT™

Cooling:

Two speed fan cooling

Protection:

Short and open circuit protection
 High temperature protection
 Primary fuses

Frequency Response:

+0, -0 dB, 20 Hz to 20 kHz at rated power into 4 ohms

DDT™ Dynamic Range:

Greater than 23 dB

DDT™ Maximum THD:

Below 0.5% for 6 dB overload
 Below 1% for 16 dB overload

Hum & Noise:

83 dB below 300 watts (20 Hz to 20 kHz)

Power Requirements:

120 V AC, 1100 watts max

Dimensions & Weight:

13.25" H x 19" W x 12.75" D
 51.4 lbs.



*Due to our efforts for constant improvements,
 features and specifications listed herein are subject to change without notice.*

XRD™ 680 PLUS LEVEL CHART

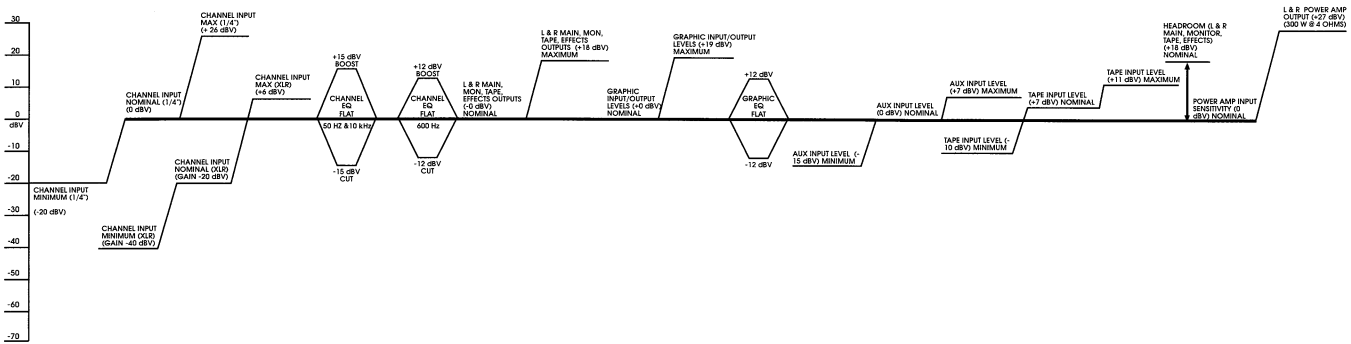

XRD™ 680S PLUS BLOCK DIAGRAM

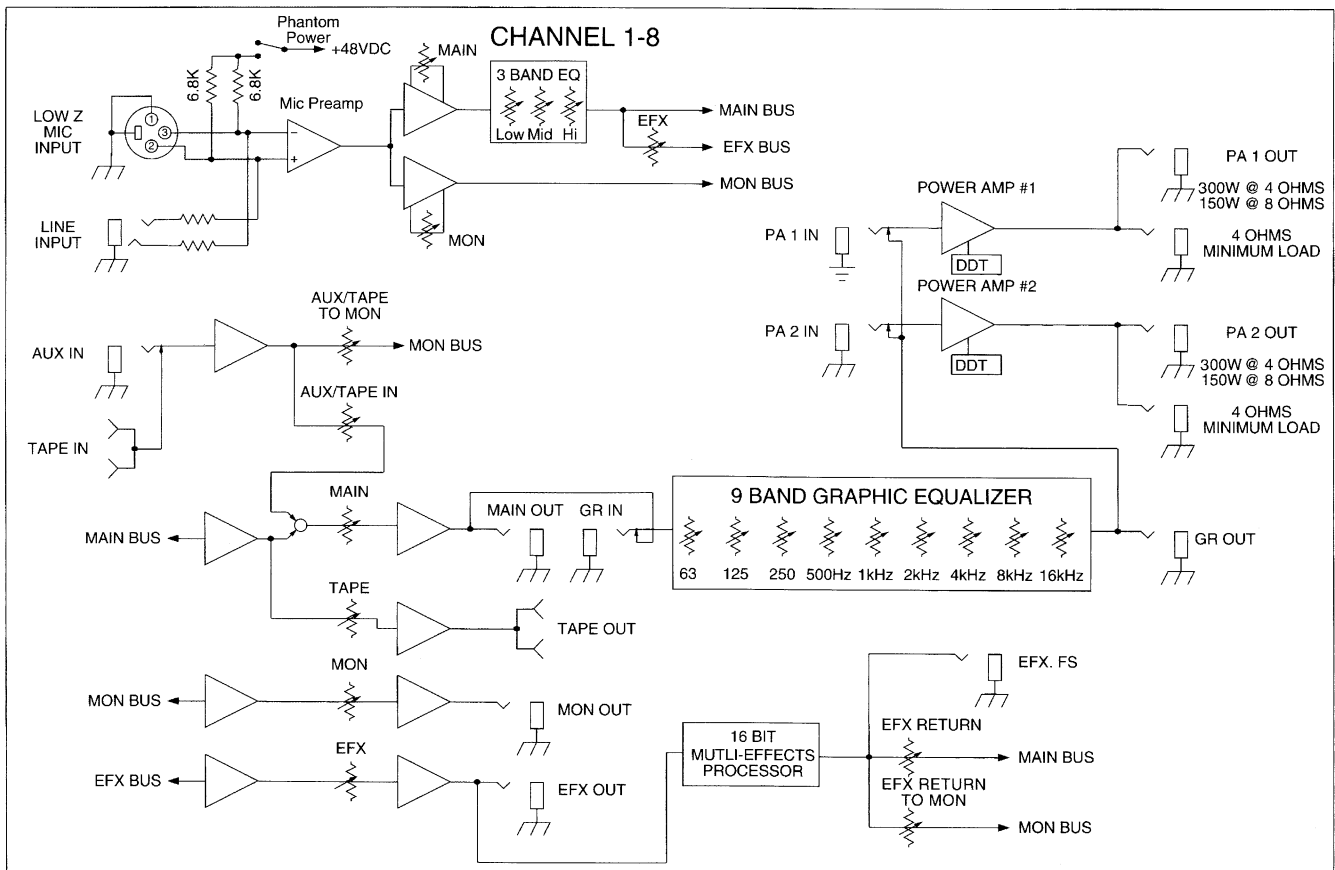

XRD 680S Plus internal EQ and power amp for mains. External EQ and power amp for monitors.

MAIN PA

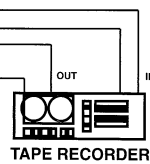
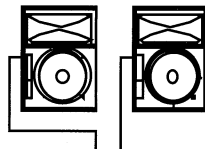

XRD 680S Plus internal EQ and external power amps for mains. External EQs and internal power amp for monitors.

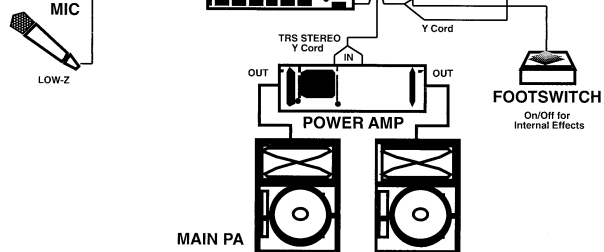
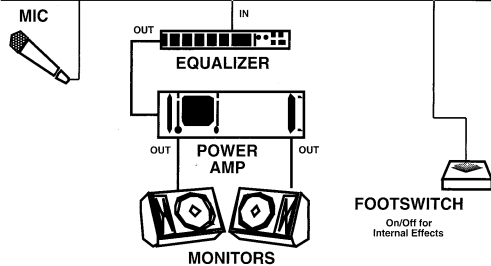
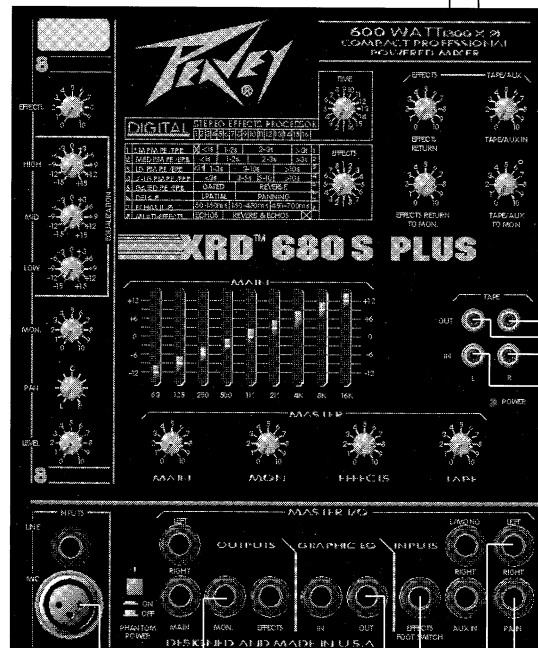

XRD 680S Plus external EQs and power amps for mains. Internal EQ and power amps for monitors.

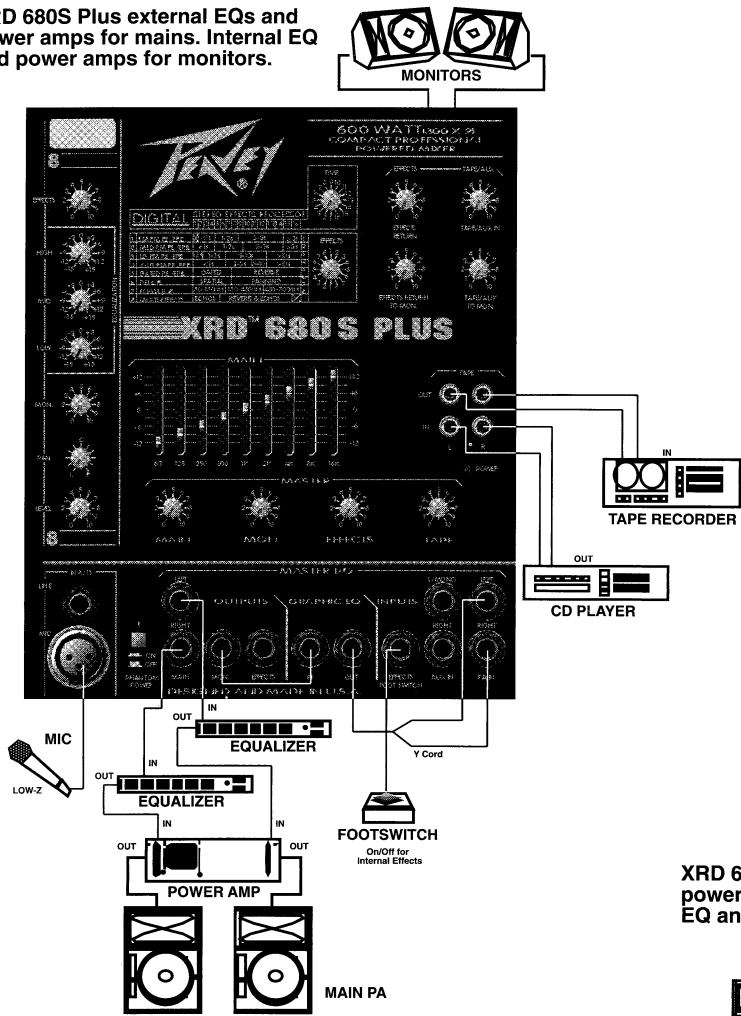

XRD 680S Plus internal EQ and power amp for mains (mono). External EQ and internal power amp for monitors.

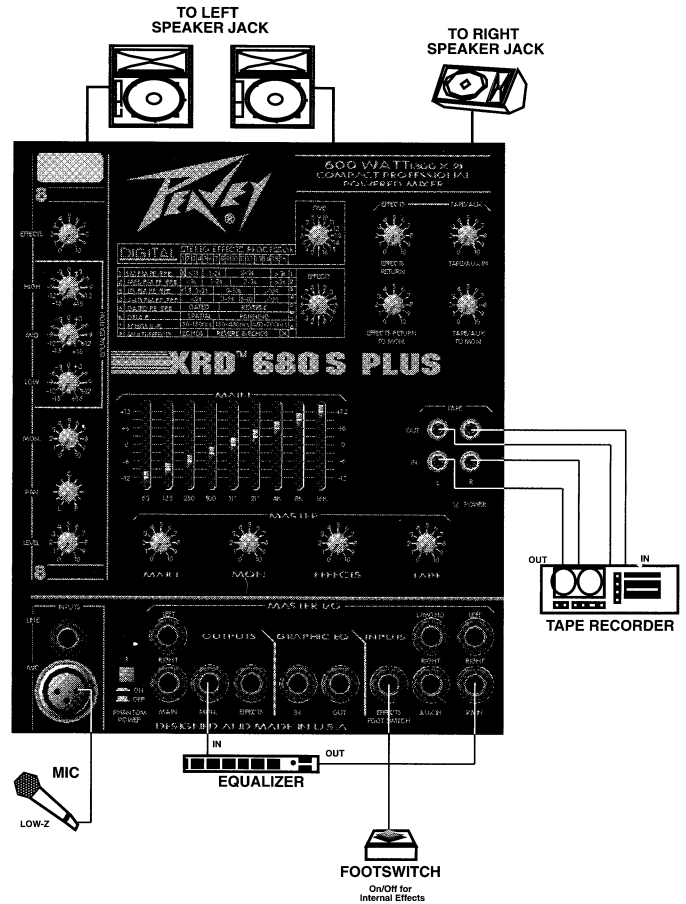

XRD 680S Plus external EQ and internal power amp for mains (mono). Internal EQ and power amp for monitors.

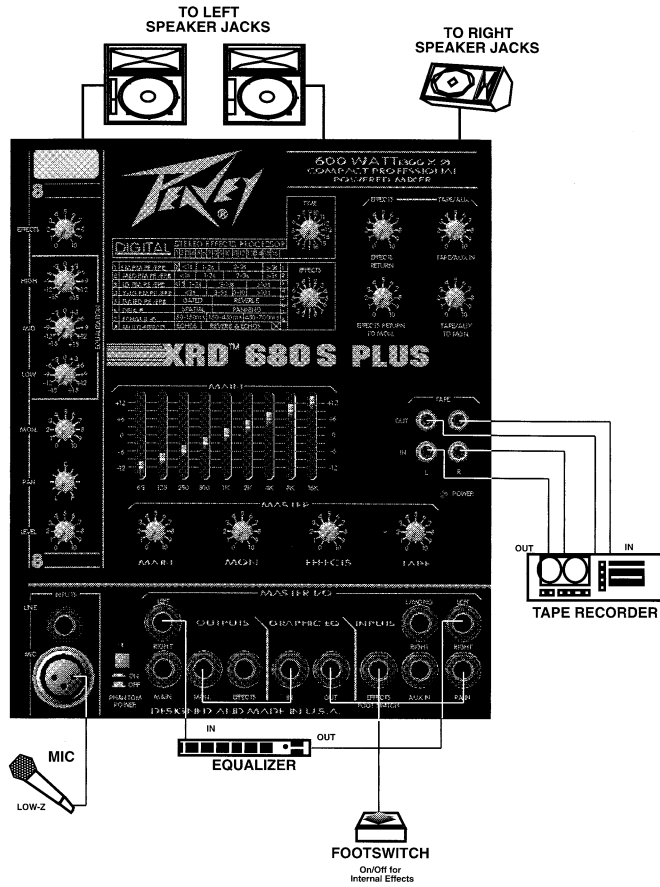

IMPORTANT SAFETY INSTRUCTIONS

WARNING: When using electric products, basic cautions should always be followed, including the following.

1. Read all safety and operating instructions before using this product.
2. All safety and operating instructions should be retained for future reference.
3. Obey all cautions in the operating instructions and on the back of the unit.
4. All operating instructions should be followed.
5. This product should not be used near water, i.e., a bathtub, sink, swimming pool, wet basement, etc.
6. This product should be located so that its position does not interfere with its proper ventilation. It should not be placed flat against a wall or placed in a built-in enclosure that will impede the flow of cooling air.
7. This product should not be placed near a source of heat such as a stove, radiator, or another heat producing amplifier.
8. Connect only to a power supply of the type marked on the unit adjacent to the power supply cord.
9. Never break off the ground pin on the power supply cord. For more information on grounding, write for our free booklet "Shock Hazard and Grounding."
10. Power supply cords should always be handled carefully. Never walk or place equipment on power supply cords. Periodically check cords for cuts or signs of stress, especially at the plug and the point where the cord exits the unit.
11. The power supply cord should be unplugged when the unit is to be unused for long periods of time.
12. If this product is to be mounted in an equipment rack, rear support should be provided.
13. Metal parts can be cleaned with a damp rag. The vinyl covering used on some units can be cleaned with a damp rag or an ammonia-based household cleaner if necessary. Disconnect unit from power supply before cleaning.
14. Care should be taken so that objects do not fall and liquids are not spilled into the unit through the ventilation holes or any other openings.
15. This unit should be checked by a qualified service technician if:
 - a. The power supply cord or plug has been damaged.
 - b. Anything has fallen or been spilled into the unit.
 - c. The unit does not operate correctly.
 - d. The unit has been dropped or the enclosure damaged.
16. The user should not attempt to service this equipment. All service work should be done by a qualified service technician.
17. This product should be used only with a cart or stand that is recommended by Peavey Electronics.
18. Exposure to extremely high noise levels may cause a permanent hearing loss. Individuals vary considerably in susceptibility to noise induced hearing loss, but nearly everyone will lose some hearing if exposed to sufficiently intense noise for a sufficient time. The U.S. Government's Occupational Safety and Health Administration (OSHA) has specified the following permissible noise level exposures.

Duration Per Day In Hours	Sound Level dBA, Slow Response
8	90
6	92
4	95
3	97
2	100
1 1/2	102
1	105
1/2	110
1/4 or less	115

According to OSHA, any exposure in excess of the above permissible limits could result in some hearing loss.

Ear plugs or protectors in the ear canals or over the ears must be worn when operating this amplification system in order to prevent a permanent hearing loss if exposure is in excess of the limits as set forth above. To ensure against potentially dangerous exposure to high sound pressure levels, it is recommended that all persons exposed to equipment capable of producing high sound pressure levels such as this amplification system be protected by hearing protectors while this unit is in operation.

SAVE THESE INSTRUCTIONS!

THIS LIMITED WARRANTY VALID ONLY WHEN PURCHASED AND REGISTERED IN THE UNITED STATES OR CANADA. ALL EXPORTED PRODUCTS ARE SUBJECT TO WARRANTY AND SERVICES TO BE SPECIFIED AND PROVIDED BY THE AUTHORIZED DISTRIBUTOR FOR EACH COUNTRY. Ces clauses de garantie ne sont valables qu'aux Etats-Unis et au Canada. Dans tous les autres pays, les clauses de garantie et de maintenance sont fixées par le distributeur national et assurées par lui selon la législation en vigueur. •• Diese Garantie ist nur in den USA und Kanada gültig. Alle Export-Produkte sind der Garantie und dem Service des Importeurs des jeweiligen Landes unterworfen. •• Esta garantía es válida solamente cuando el producto es comprado en E.U. continentales o en Canada. Todos los productos que sean comprados en el extranjero, están sujetos a las garantías y servicio que cada distribuidor autorizado determine y ofrezca en los diferentes países.

PEAVEY ONE-YEAR LIMITED WARRANTY/REMEDY

PEAVEY ELECTRONICS CORPORATION ("PEAVEY") warrants this product, EXCEPT for covers, footswitches, patchcords, tubes and meters, to be free from defects in material and workmanship for a period of one (1) year from date of purchase, PROVIDED, however, that this limited warranty is extended only to the original retail purchaser and is subject to the conditions, exclusions, and limitations hereinafter set forth:

PEAVEY 90-DAY LIMITED WARRANTY ON TUBES AND METERS

If this product contains tubes or meters, Peavey warrants the tubes or meters contained in the product to be free from defects in material and workmanship for a period of ninety (90) days from date of purchase; PROVIDED, however, that this limited warranty is extended only to the original retail purchaser and is also subject to the conditions, exclusions, and limitations hereinafter set forth.

CONDITIONS, EXCLUSIONS, AND LIMITATIONS OF LIMITED WARRANTIES

These limited warranties shall be void and of no effect, if:

- a. The first purchase of the product is for the purpose of resale; or
- b. The original retail purchase is not made from an AUTHORIZED PEAVEY DEALER; or
- c. The product has been damaged by accident or unreasonable use, neglect, improper service or maintenance, or other causes not arising out of defects in material or workmanship; or
- d. The serial number affixed to the product is altered, defaced, or removed.

In the event of a defect in material and/or workmanship covered by this limited warranty, Peavey will:

- a. In the case of tubes or meters, replace the defective component without charge.
- b. In other covered cases (i.e., cases involving anything other than covers, footswitches, patchcords, tubes or meters), repair the defect in material or workmanship or replace the product, at Peavey's option; and provided, however, that, in any case, all costs of shipping, if necessary, are paid by you, the purchaser.

THE WARRANTY REGISTRATION CARD SHOULD BE ACCURATELY COMPLETED AND MAILED TO AND RECEIVED BY PEAVEY WITHIN FOURTEEN (14) DAYS FROM THE DATE OF YOUR PURCHASE.

In order to obtain service under these warranties, you must:

- a. Bring the defective item to any PEAVEY AUTHORIZED DEALER or AUTHORIZED PEAVEY SERVICE CENTER and present therewith the ORIGINAL PROOF OF PURCHASE supplied to you by the AUTHORIZED PEAVEY DEALER in connection with your purchase from him of this product. If the DEALER or SERVICE CENTER is unable to provide the necessary warranty service you will be directed to the nearest other PEAVEY AUTHORIZED DEALER or AUTHORIZED PEAVEY SERVICE CENTER which can provide such service.

OR

- b. Ship the defective item, prepaid, to:

PEAVEY ELECTRONICS CORPORATION
International Service Center
326 Hwy. 11 & 80 East
MERIDIAN, MS 39301

including therewith a complete, detailed description of the problem, together with a legible copy of the original PROOF OF PURCHASE and a complete return address. Upon Peavey's receipt of these items:

If the defect is remedial under these limited warranties and the other terms and conditions expressed herein have been complied with, Peavey will provide the necessary warranty service to repair or replace the product and will return it, FREIGHT COLLECT, to you, the purchaser.

Peavey's liability to the purchaser for damages from any cause whatsoever and regardless of the form of action, including negligence, is limited to the actual damages up to the greater of \$500.00 or an amount equal to the purchase price of the product that caused the damage or that is the subject of or is directly related to the cause of action. Such purchase price will be that in effect for the specific product when the cause of action arose. This limitation of liability will not apply to claims for personal injury or damage to real property or tangible personal property allegedly caused by Peavey's negligence. Peavey does not assume liability for personal injury or property damage arising out of or caused by a non-Peavey alteration or attachment, nor does Peavey assume any responsibility for damage to interconnected non-Peavey equipment that may result from the normal functioning and maintenance of the Peavey equipment.

UNDER NO CIRCUMSTANCES WILL PEAVEY BE LIABLE FOR ANY LOST PROFITS, LOST SAVINGS, ANY INCIDENTAL DAMAGES, OR ANY CONSEQUENTIAL DAMAGES ARISING OUT OF THE USE OR INABILITY TO USE THE PRODUCT, EVEN IF PEAVEY HAS BEEN ADVISED OF THE POSSIBILITY OF SUCH DAMAGES.

THESE LIMITED WARRANTIES ARE IN LIEU OF ANY AND ALL WARRANTIES, EXPRESSED OR IMPLIED, INCLUDING, BUT NOT LIMITED TO, THE IMPLIED WARRANTIES OF MERCHANTABILITY AND FITNESS FOR A PARTICULAR USE; PROVIDED, HOWEVER, THAT IF THE OTHER TERMS AND CONDITIONS NECESSARY TO THE EXISTENCE OF THE EXPRESSED, LIMITED WARRANTIES, AS HEREINABOVE STATED, HAVE BEEN COMPLIED WITH, IMPLIED WARRANTIES ARE NOT DISCLAIMED DURING THE APPLICABLE ONE-YEAR OR NINETY-DAY PERIOD FROM DATE OF PURCHASE OF THIS PRODUCT.

SOME STATES DO NOT ALLOW LIMITATION ON HOW LONG AN IMPLIED WARRANTY LASTS, OR THE EXCLUSION OR LIMITATION OF INCIDENTAL OR CONSEQUENTIAL DAMAGES, SO THE ABOVE LIMITATIONS OR EXCLUSIONS MAY NOT APPLY TO YOU. THESE LIMITED WARRANTIES GIVE YOU SPECIFIC LEGAL RIGHTS, AND YOU MAY ALSO HAVE OTHER RIGHTS WHICH MAY VARY FROM STATE TO STATE.

THESE LIMITED WARRANTIES ARE THE ONLY EXPRESSED WARRANTIES ON THIS PRODUCT, AND NO OTHER STATEMENT, REPRESENTATION, WARRANTY, OR AGREEMENT BY ANY PERSON SHALL BE VALID OR BINDING UPON PEAVEY.

In the event of any modification or disclaimer of expressed or implied warranties, or any limitation of remedies, contained herein conflicts with applicable law, then such modification, disclaimer or limitation, as the case may be, shall be deemed to be modified to the extent necessary to comply with such law.

Your remedies for breach of these warranties are limited to those remedies provided herein and Peavey Electronics Corporation gives this limited warranty only with respect to equipment purchased in the United States of America.

INSTRUCTIONS — WARRANTY REGISTRATION CARD

1. Mail the completed WARRANTY REGISTRATION CARD to:

PEAVEY ELECTRONICS CORPORATION
POST OFFICE BOX 2898
MERIDIAN, MISSISSIPPI 39302-2898

- a. Keep the PROOF OF PURCHASE. In the event warranty service is required during the warranty period, you will need this document. There will be no identification card issued by Peavey Electronics Corporation.
2. IMPORTANCE OF WARRANTY REGISTRATION CARDS AND NOTIFICATION OF CHANGES OF ADDRESSES:
 - a. Completion and mailing of WARRANTY REGISTRATION CARDS — Should notification become necessary for any condition that may require correction, the REGISTRATION CARD will help ensure that you are contacted and properly notified.
 - b. Notice of address changes — If you move from the address shown on the WARRANTY REGISTRATION CARD, you should notify Peavey of the change of address so as to facilitate your receipt of any bulletins or other forms of notification which may become necessary in connection with any condition that may require dissemination of information or correction.
3. You may contact Peavey directly by telephoning (601) 483-5365.



Features and specifications subject to change without notice.

Peavey Electronics Corporation 711 A Street / Meridian, MS 39301 / U.S.A. / (601) 483-5365 / Fax 486-1278

©1995

#80302401

Printed in U.S.A. 10/95